



**FENDT**

# Fendt 700 Vario Gen7





## Fendt 700 Vario Gen7.

4	At a glance.	40	Cab.
6	Spotlights.	50	Smart Farming.
12	Engine.	62	Front loader.
18	Transmission.	66	Fendt Services.
24	Hydraulics.	72	Technical specifications.
32	Structure.	74	Technical Details.

## At a glance.

### Fendt 700 Vario Gen7 – You dreamt it. We built it.

Inspired by the needs and ideas of our customers and our claim to produce the best innovations and technologies, we have developed a tractor that leaves nothing to be desired - the Fendt 700 Vario Gen7.

- Power segment 203 - 283 hp + 20 hp (on the Fendt 728 Vario with the DynamicPerformance additional performance concept)
- New generation of engines from AGCO Power: CORE 75, 7.5 l cubic capacity, 6 cylinders, Fendt iD low-speed concept with only 1,700 rpm rated speed
- Cooling concept: Concentric Air System (CAS) with pressurised fan (similar to the Fendt 1000 Vario)
- New generation single-stage VarioDrive drive transmission (TA 190) with independent, intelligent all-wheel drive, torque distribution + pull-in turn technology, four-speed rear PTO
- Permanent, tension-free all-wheel drive: perfect symbiosis of max. tractive power, superior ground protection on any surface without tension and driver stress
- Elimination of manual switching when switching between range I and II
- Fendt iD low-speed concept with only 1700 rpm rated speed
- Outstanding economy in the neutral DLG PowerMix test with 242/24.2 g/kWh diesel/AdBlue in the field and 332/33.3 g/kWh diesel/AdBlue at 40 km/h in transport - best tractor tested in the PowerMix 2.0 (as of Jan 2024) in the hp range of up to 305 hp
- Outstanding manoeuvrability: turn radius of only 11.8 m with 600/70 R30 tyres
- High-performance hydraulics: up to 220 l flow rate, flat-face FFC couplings at the front and rear, rear power lift with load relief control, hydraulic top link with lifting aid; up to 10 electric valves rear/centre/front – with 5/3/2
- New generation front loader: Fendt CargoProfi 6.100 - outstanding loading performance combined with extreme manoeuvrability in the 300 hp class
- Tyres with a diameter of up to 2.05 m (compared to 1.95 m on the Fendt 700 Vario Gen6)
- The VarioGrip integrated tyre pressure system
- High payload of up to 6.2 t - Extremely low power-to-weight ratio of only 30.5 kg/hp for the top model Fendt 728 Vario
- VisioPlus cabin with cat. 4 filter protection function according to EN15695\*: Protection against dust, pesticides and their vapours
- FendtONE operating philosophy:
  - FendtONE driver workplace (onboard)
  - Planning and management functions with FendtONE offboard
- Safety assistance systems: Trailer Brake Assist, Fendt Stability Control (FSC)

Engine		720 Vario Gen7	722 Vario Gen7	724 Vario Gen7	726 Vario Gen7	728 Vario Gen7
Maximum power ECE R 120	kW/hp	149/203	164/223	179/243	193/262	
Maximum power with DP ECE R 120	kW/hp					223/303



# Fendt 700 Vario Gen7 Spotlights.

Here you will find unique Fendt solutions.  
Fendt Spotlights, which make all the  
difference too you and make your working day  
go much faster.



## 1. New engine with Fendt iD low-speed concept

- Newly developed AGCO Power engine with 7.5 litre capacity
- Fendt iD low-speed concept: low fuel consumption thanks to significant reduction of the nominal speed to 1,700 rpm
- Perfect combination of all vehicle components such as engine, transmission, fan and hydraulics and all auxiliary consumers to ideal speeds
- Reaching the highest torque even at low speeds
- Continuously low fuel consumption
- Extended life performance

## 2. Fendt DynamicPerformance: intelligent multi-performance concept for the Fendt 728 Vario

- Up to 20 hp more power regardless of driving speed: 283 hp + 20 hp power on the Fendt 728 Vario
- Compared to conventional boost concepts, DP extra power is also available when cultivating and when stationary
- More area performance and higher productivity
- Lighter tractor with higher power
- Less fuel consumption per ha

## 3. Intelligent VarioDrive

- Maximum comfort due to omission of travel range switching I / II
- Independent drive of front and rear axle
- No manual all-wheel drive switch necessary
- Optimum engine/transmission matching in conjunction with Fendt iD low-speed concept
- Smallest possible turning radius due to pull-in turn effect, optimal for front loader work
- Change gear oil only every 2,000 operating hours
- No special oil necessary
- Zippy handling: 40, 50 or up to 60 km/h

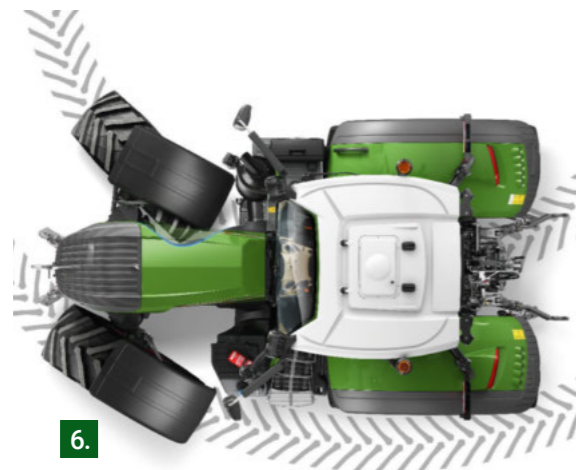

6.

**4. Extremely low power-to-weight ratio combined with maximum payload**

- Power-to-weight ratio of only 30.5 kg/hp for the top model Fendt 728 Vario
- High payload of up to 6.2 t with a permissible gross weight of 15 t (40 km/h and 50 km/h versions)

**5. Cooling concept: Concentric Air System (CAS) with pressurised fan**

- Concentric, pressure fan with independent, hydraulic drive
- Extremely narrow compact fan enables outstanding visibility and a tight steering angle - Outstanding manoeuvrability
- High efficiency due to fan arrangement in front of the cooling package
- Extremely efficient: up to 40% less drive power than standard fans - more available power and fuel savings



8.

- Reversible fan function: independent cleaning of the radiator grill adapted to the requirements of the individual units; Interval-controlled reversible fan function possible - time-dependent programmable in the terminal
- Maximum comfort by integrating the reversible fan into the headland management system

**6. Superior manoeuvrability**

- Turning radius of only:
  - 10.0 m with 540/65 R30 tyres
  - 11.8 m with 600/70 R30 tyres - enormous manoeuvrability in the 300 hp class

**7. High-performance hydraulics**

- Up to 220 l flow rate
- Modular hydraulic coupling system: UDK, DUDK or flat-face FFC couplings at the front and rear - less pressure loss, reduced consumption, leak-free
- Load relief control rear power lift
- Hydraulic top link with lifting aid (rear)

**8. Integrated tyre pressure control system VarioGrip in combination with larger tyres**

- New tyre dimensions: Diameter of up to 2.05 m at the rear and 1.60 m at the front for maximum ground protection and traction
- Fully integrated tyre pressure regulation system with built valve and air lines
  - Up to 8% diesel savings and up to 10% more tractive power in the field
- VarioGrip suitable for stub and flange axle and compatible with Row Crop tyres
- No risk of air lines being torn off thanks to built in protection
- Simple operation via the terminal

**9. Safety assistance systems for increased safety and improved driving comfort**

- Fendt Stability Control: At driving speeds of over 20 km/h, it automatically reduces body roll and actively suppresses body roll when cornering
- Trailer brake assistant (TBA): stabilises the combination with a pneumatically braked trailer in critical situations. Safety function is only activated when required (up to 25 km/h) and provides additional safety while protecting the field or grass sward at the same time.

**10. Digital bonnet and rear camera**

- High-resolution for the best image quality
- Good view of the front power lift or the implement at the rear
- Maximum safety due to visibility into the front and rear work area

**11. VisioPlus cabin**

- Spacious cab with a continuous 77° field of vision, ideal for front loader work
- Wide and therefore comfortable entry
- Space for a large cooler and warmer for long working days
- Powerful air conditioning with exceptional cooling in hot conditions
- Additional side window wiper
- Numerous storage compartments

**12. New Premium Driver's Seat**

- Electric adjustment of the backrest, side bolsters and lumbar support; electric longitudinal adjustment
- Massage function available
- Multi-stage seat heating and air conditioning
- Memory function
- Operating and setting the seats comfort functions done via the terminal





### 13. FendtONE onboard

- Simple, customisable operation with central arrangement of all controls
- 3L joystick with direction change button and up to 27 functions on three operating levels
- Up to three display options: 10" dashboard, 12" terminal on armrest, 12" terminal retractable into the cab roof
- Extensive automation of processes via Section Control, T1 Headland and TIM

### 14. FendtONE offboard

- Agronomy: Plan activities in the field and receive comprehensive reports
- Guidance: manage field boundaries and way lines and keep them consistent across the fleet
- Telemetry: monitor key machine data and live fleet positions in the field

### 15. Cab with pre-equipment for Cat. 4 filter protection function

- Exchangeable filter system from the factory according to EN15695: protection against dust, pesticides and their vapours

### 16. New front loader generation, Fendt Cargo 6.100

- Max. lift capacity of 4,070 kg and 4.85 m lift height for outstanding loading performance, combined with extreme manoeuvrability in the 300 hp class
- Weighing possible in every position (individual and total weight)
- Display of maintenance intervals via the terminal
- Own valve block with separate front loader valves
- Work lights on the boom
- New universal bucket with 2.55 m width available
- New multi-coupler

### 17. Warranty extension Fendt Care

- Complete coverage for 8 years/8,000 hrs on the entire vehicle and front loader - longest coverage on the market for tractors
- Full cost control and planning security





## Engine.

The engine specially developed for the Fendt 700 Vario Gen7 leaves nothing to be desired. It reaches its full torque already at 1300 rpm - pure power with low fuel consumption.



### 1. Features

- New engine generation: AGCO Power engine – 7.5 litre capacity; 6 cylinders; 4-valve technology
- Fendt iD technology (low speed concept) - speed range from 700 rpm (idling) to 1,700 rpm (rated speed)
- Electronically controlled wastegate turbocharger
- Compliance with the limit values for exhaust gas regulations Stage V (EU) and TIER 4 final, as well as LRC
- Hydraulic tappet for automatic valve lash adjustment and smooth, low-vibration engine running
- Approved for HVO fuels according to DIN 15940



- + Very high power reserves
- + Maximum fuel efficiency through low-speed concept Fendt iD
- + Quiet and fuel-saving idling
- + Low noise level of the engine
- + Reduced maintenance thanks to hydraulic tappets
- + Approved for HVO fuels according to DIN 15940

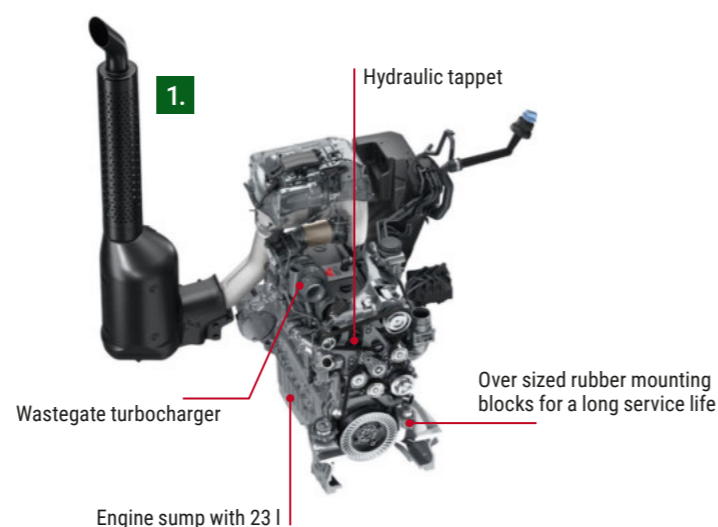

### Power/torque

- Intelligent additional performance concept DynamicPerformance (DP) with up to 20 hp extra performance
- Increase in available power through highly efficient fan drive
- Improved dynamics compared to the Fendt 700 Vario Gen6 / 800 Vario S4
- Fendt iD low-speed concept: high torque at low engine speeds
  - >> Speed range: of only 700 - 1,700 rpm
  - >> Low rated speed of 1,700 rpm for low fuel consumption, low noise level and less wear
  - >> Full torque curve and full torque already from 1,300 rpm
- Engine perfectly matched to VarioDrive driveline
- Up to 150 Nm more torque at low engine speeds compared to the predecessor model:
  - 724 Vario Gen6: 1,072 Nm / 1,450 rpm
  - vs. 724 Vario Gen7: 1,220 Nm / 1,300 rpm
  - Increase in starting and constant torque compared to the Fendt 700 Vario Gen6 / 800 Vario S4
- Final speed at reduced engine speed
  - 40 km/h at 950 rpm
  - 50 km/h at 1,200 rpm
  - 60 km/h at 1,450 rpm



- + Extremely economical in fuel consumption

### Specific fuel and AdBlue consumption

- Fuel efficiency: engine can always be driven in the range of the lowest specific consumption
- Fendt iD low-speed concept: high torque at low engine speeds for low fuel consumption
- Further increase in fuel efficiency thanks to high-performance fan

### 2. Emission stage V (EU) / emission standard TIER 4 final

- Exhaust gas treatment with
  - Diesel Oxidation Catalysor (DOC)
  - Diesel Particulate Filter (DPF)
  - Selective catalytic reduction (SCR) with AdBlue
- Omission of exhaust gas recirculation
- SCR catalytic converter with optimised visibility positioned in front of the right-hand A-column
- Same components and exhaust treatment system in all markets/for all exhaust stages

#### Procedure:

- Diesel oxidation catalytic converter (DOC) reduces carbon monoxide and hydrocarbons
- Diesel particulate filter ensures reduction of particles
- Thanks to common rail high-pressure injection and electronic engine control, combustion is optimised, reducing the number of soot particles to a minimum
- Diesel particulate filter regenerates itself under normal operating conditions; standstill regeneration possible
- SCR technology (Selective Catalytic Reduction) removes the main proportion of nitrogen oxides (NO<sub>x</sub>)
- Ideal mixing of AdBlue and exhaust gases, thus achieving a high conversion rate

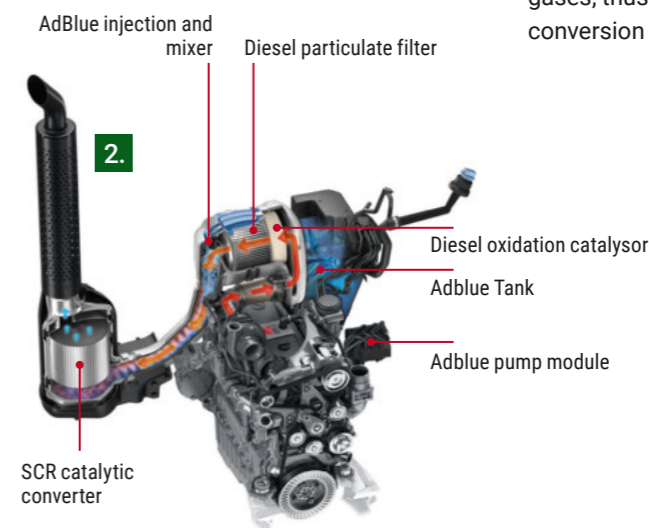





**Cooling concept: Concentric Air System (CAS) with pressurised fan - overview**

- Concentric, pressure fan with independent, hydraulic drive
- Extremely narrow compact fan (560 mm) enables a narrow bonnet and combines outstanding clarity with excellent manoeuvrability
- High efficiency due to fan arrangement in front of the cooling package
- Extremely efficient: less drive power required, up to 40% more economical than a conventional standard cooler in normal operation >> more available power and diesel savings of up to 1,320 l/1,000 operating hours (compared to Fendt 800 Vario S4)

- Fans with large power reserves; cooling system designed for 45° C outside temperature
- Reversible fan function an option



- + Compact fan enables very good forward visibility and outstanding manoeuvrability
- + High overall efficiency due to fan and air intake
- + Low noise level due to low fan speed
- + Low power consumption of the fan

**1. Cooling concept: Concentric Air System (CAS) with pressurised fan - Mode of operation**

- Pressing high-performance fan in front of the cooler pack draws in cold, dense air >> low air temperature and the resulting higher air density on the fan blades increase efficiency
- Air is accelerated quickly via concentrically shaped blades and forced through the radiators
- Own hydraulic drive for ideal cooling performance, independent of engine speed and needs-based cooling for each component
- Each cooler can control the fan separately (cooling management)
- Fan has excellent efficiency due to the blade geometry and the small gap to the cowl (1 – 2 mm)

**Reversible fan function**

- Independent cleaning of the radiator grill
- Reversing fan drive by variable displacement pump (axial piston pump, electrically adjustable)
- Reversing motor (axial piston motor, electrically adjustable)
- Normal operation: normal direction of rotation
- Reverse: Motor is adjusted in reverse direction of rotation
- Control via the terminal:
  - Manual: Activating the reversible fan function in the terminal
  - Automatic: interval-controlled - programmable in the terminal depending on time



- + Optimal for dusty conditions, e.g. mowing, straw baling, non-agricultural use
- + Automation: interval-controlled reversible fan function possible - time-dependent programmable in the terminal
- + Maximum comfort through integration in the Fendt TI headland management system
- + Highest fuel efficiency also with the reversible fan by adapting the cooling capacity to the demand of the individual units

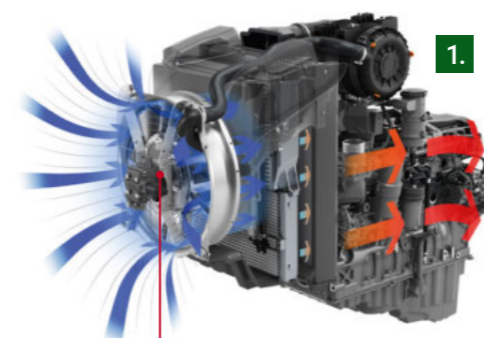

Hydraulic fan drive

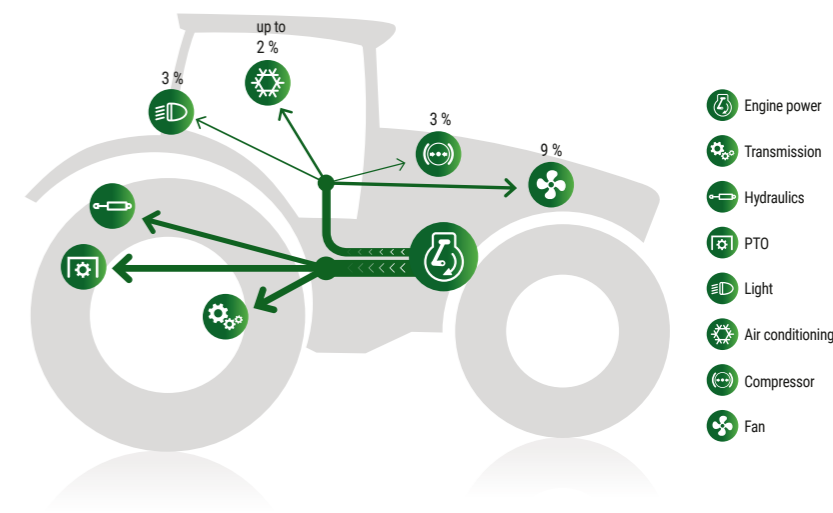

**Fendt DynamicPerformance**

**Intelligent multi-performance concept**

Fendt DynamicPerformance (DP): intelligent extra power concept that compensates for power losses and ensures consistent work performance

Requirements for an intelligent multi-performance concept:

- Engine power must feed numerous auxiliary consumers in addition to main consumers: whether in tillage, PTO work, transport or PTO work when stationary

Known boost concepts with numerous restrictions in practical use only available in narrowly defined application situations:

- Not designed for continuous operation, not in stationary operation e.g. diet feeder mixer wagon
- Boost power is only available under certain conditions, e.g. from certain driving speeds, activated PTO, etc.

**Operational advantages**

1. Lighter tractor with higher power
2. Intelligent, sensor-controlled solution independent of fixed parameters, such as speed
3. Additional availability of the intelligent extra power even when cultivating the soil at low speeds and when stationary compared to conventional boost concepts
4. More area output due to higher driving speed
5. Less fuel consumption per ha

>> Higher productivity



## Transmission.

Fendt VarioDrive - the revolutionary further development of the proven Fendt Vario transmission. Unique thanks to independent drive of front and rear axle, intelligent all-wheel drive, elimination of drive range shifting and much more.

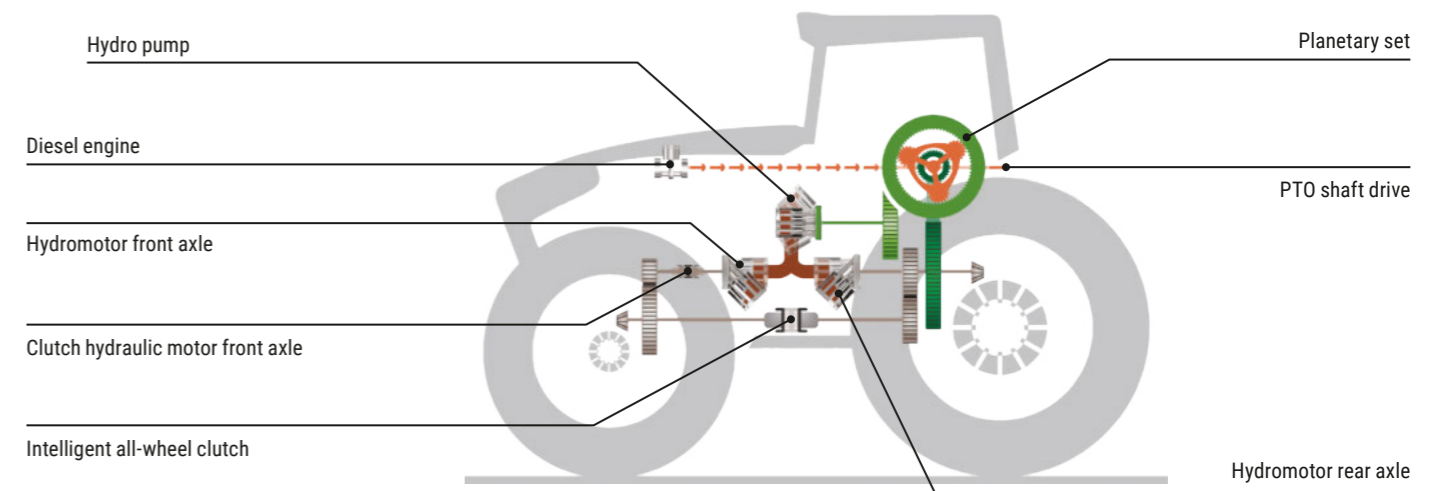

**VarioDrive drive train with permanent 4WD**

- Revolutionary further development of the proven Fendt Vario transmission
- Well-known and 100% proven in the large tractors Fendt 900 Vario and 1000 Vario
- Efficient drive train with permanent, independent 4WD for maximum tractive power and superior ground protection on any surface
- No travel range switching
- Infinitely variable speeds from 20 m/h to 60 km/h (at reduced engine speed)
- Separate hydraulic motors for front and rear axle, which act on the respective axle
- Fully automatic power distribution between front and rear axle with intelligently controlled all-wheel drive:
  - Improved handling on slippery surfaces
  - More soil protection at the headland

- The perfect symbiosis of maximum tractive power and superior ground protection on any surface without tension and driver stress
- Easy to use thanks to smart and automatic power distribution with maximum soil protection during grassland and front loader work
- Less tyre wear compared to drive types with classic all-wheel drive
- Pull-in-turn effect for best manoeuvrability when cornering, pulls the machine into the curve during turning manoeuvres instead of the negative influence of conventional rigid four-wheel drive on the turning circle.

**Variable all-wheel drive through Fendt Torque Distribution – field use**

- Traction always where it is needed. Torque is dynamically distributed to front and rear axle depending on ground conditions
- Torsion-free 4WD through separate drive of the front axle
- During heavy towing work, the all-wheel clutch closes (detection via transmission pressure)
- The driver's workload is reduced, as they no longer have to engage and disengage the all-wheel drive
- When driving around an obstacle or cornering, always apply full traction to the front axle

**Permanent 4WD through Fendt Torque Distribution – Manoeuvrability Pull-in turn**

- The front axle "pulls" the tractor around the curve and achieves a "pull-in turn" effect
- Comparable vehicle has 10 % larger turning radius in the field without VarioDrive
- Always the smallest turning radius with full traction on the front axle
- Facilitates, e.g., turning at the headland
- Less manoeuvring about due to an always-tighter turning radius
- Smart power distribution for maximum soil protection during grassland and front loader work.

**Improved comfort – Focus on the essentials**

- Driver relief: No travel range switching; entire power range is travelled through in one travel range
- No manual all-wheel drive transmission required
- Intelligently controlled all-wheel clutch automatically adjusts the traction distribution without the driver having to intervene



**Higher efficiency and effectiveness**

- Rear-axle hydromotor and mechanical power split are directly connected to the rear-axle drive - Elimination of the driving range switch
- Front axle hydromotor is directly connected to front axle
- Front axle hydromotor is decoupled from approx. 25 km/h
  - Large efficiency gain of up to 10 kW
  - More usable power, especially in transport, and thus lower fuel consumption
  - Maximum traction and highest efficiency

**Full road capability**

- Lightweight basic vehicle for high payload
- 40 km/h at 950 rpm, 50 km/h at 1,200 rpm, 60 km/h at 1,450 rpm, thus predestined for, e.g., transport work, fast and cost-saving
- Torsion-free all-wheel drive, even on the road and when cornering
- No loss of power between front and rear axle, thus less tyre wear and fuel consumption



**Benefits**

- + Front and rear axle are driven independently
- + No manual all-wheel drive, driver is relieved of workload
- + Hydromotor on the front axle is swung back at approx. 25 km/h and is decoupled
- + Optimum engine-transmission matching in conjunction with Fendt iD low-speed concept
- + Smallest possible turning radius due to Pull-in turn effect
- + Change gear oil only every 2,000 operating hours
- + No additional super creeper transmission necessary
- + Universal application possibilities

**Four-speed rear PTO**

- 540/540E/1000/1000E
- High degree of efficiency with almost direct through-drive from the crankshaft to the PTO stub shaft (only one gear stage in PTO transmission)
- High efficiency
- Electro-hydraulic speed preselection
- External operation on both sides of the mudguard
- PTO stub detection
- Bevelled PTO profile enables particularly easy attachment of the stub shaft
- 1000E economy PTO:
  - 1,000 PTO revolutions are available at an engine speed of 1,308 rpm

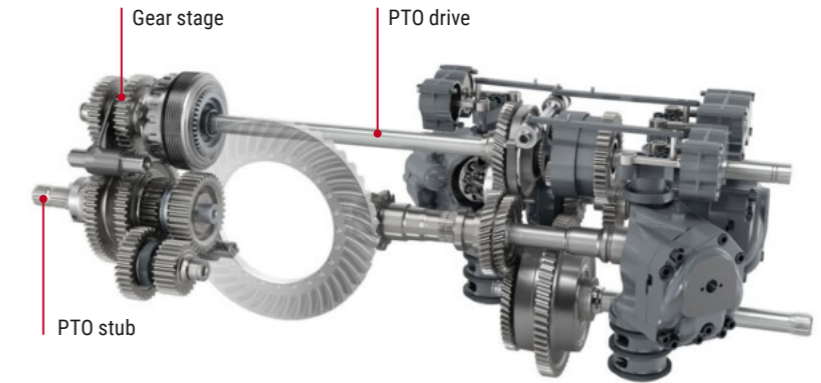

- + PTO-driven units can be operated at constant speed and at the same time variable travel speed
- + Exchange of various PTO stubs

**Automatic functions PTO**

- Switching the rear PTO on and off can be assigned to buttons on the drive lever
- The PTO is switched on and off automatically at preset positions of the power lift
- PTO off point can be set with the rear power lift position
- Starting an adjustable engine speed when activating the PTO on the mudguard (slurry tanker)
- Fully integrated into the Fendt TI headland management system



External rear PTO operation



- + Simplified operation due to the relation between power lift height and PTO start / stop
- + Simplified operation on the multifunction joystick



## Hydraulics.

Versatile hydraulic system with modular structure. The Fendt 700 Vario Gen7 can be individually equipped according to your needs: For example, with a load-sensing pump with an oil delivery rate of up to 220 l/min.



**Features**

- 2 different versions: 165 l/min or 220 l/min flow rate
- Variable displacement pumps with electric load sensing:
  - Power/Power+: standard load-sensing pump with 165 l/min pump capacity
  - Profi/Profi+: optional load-sensing pump with 220 l/min pump capacity
- Pilot pressure generation via LS pump instead of via power steering pump (gear pump)
- Large removable oil quantity of 80 litres
- Separate transmission and hydraulic oil supply with heat exchanger concept

- Optimal ergonomic arrangement of the operating elements for working hydraulics and power lift
- Numerous setting options via the terminal (free assignment of operating locations, time function, oil quantity setting,...)
- Hydraulic oil preheating
- Hydraulic oil change intervals of 2,000 operating hours or 2 years (biohydraulic oil 1,000 h or 1 year)



- + High pump capacity of up to 220 l/min for work with high oil volume at low engine speed
- + Low maintenance costs due to long oil change intervals
- + Up to 2,000 hrs oil change interval (not bio-oil) under normal operating conditions with Profi/Profi+ thanks to electronic oil filter monitoring
- + Very good steering response, even with parallel consumption
- + High removable oil volume for reliable supply for large consumers
- + Use of bio-hydraulic oils supported due to separate oil reservoir
- + No oil mixing/dirt ingress
- + Outstanding ease of use
- + Faster full functionality even in cold weather

**1. Working hydraulics - equipment features**

- Max. number of valves for Power:
  - A total of max. 6 double-acting valves (front 1, centre 2 and rear up to 3 for front valve, otherwise, rear max. 4) plus Power Beyond
- Max. number of valves with Power+:
  - A total of max. 7 double-acting valves (front 1, centre 2 and rear 4) plus Power Beyond
- Max. number of valves for Profi/Profi+:
  - A total of max. 10 double-acting valves (front 2, centre 3 and rear 5) plus Power Beyond
- Power Beyond Connection
- Choice of valve coupling:
  - UDK couplings (can be coupled under pressure; flow rate of 120 l/min; series)
  - DUDK couplings (can be coupled under pressure on both sides; flow rate of 140 l/min; optional)
  - FFC couplings (Flat Face Coupling, flat-sealing, double-sided, can be coupled under pressure, always as 5/8" cartridge; NEW: additionally also Power Beyond and Front-Valves available as FFC; optional)
- Left/right valve block can be equipped independently with FFC couplings, either standard or FFC couplings
- Flow rate of 170 l/min on the 3rd and 4th valve with 3/4" or 5/8" FFC
- Flow rate adjustable for each valve (+ and - separately)
- Removable hydraulic oil quantity: 80 litres
- External actuation on both sides available for a freely assignable additional control unit
- Centre valves also with timer functions and integration into the teach-in if no front loader is fitted

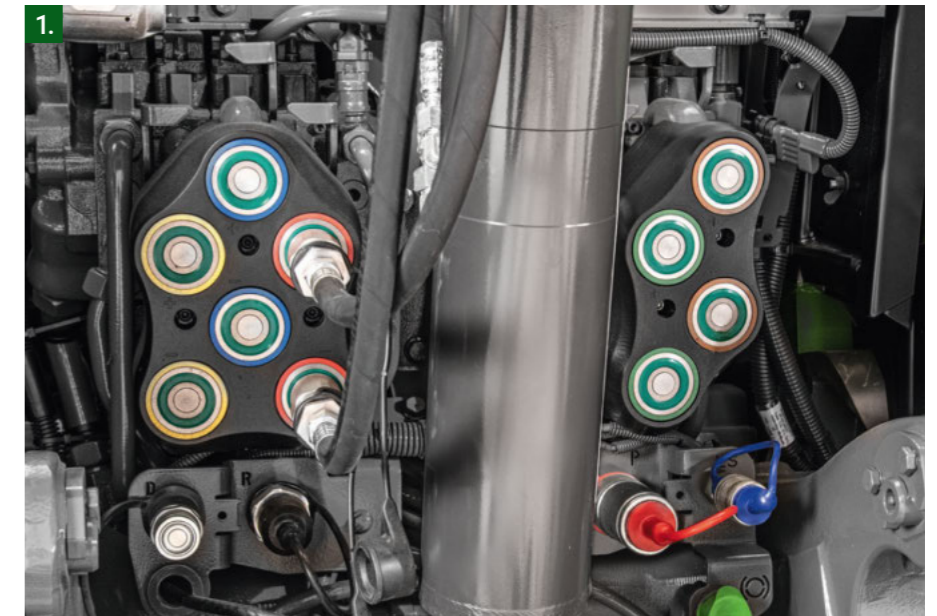

**Automatic steering axle lock**

- Automatic locking and unlocking of the trailer steering axle above and below definable speeds
- Steering axle is always locked when reversing
- Activation and setting of the speed range (lower limit: 0-3 km/h; upper limit 10-25 km/h) as well as assignment of the hydraulic valve in the terminal
- Automatic override possible



- + Enormous relief to the driver and comfort gain
- + Less tyre wear
- + Increased driving stability
- + Enormous gain in safety
- + Avoidance of accidents and damage
- + Simple operation

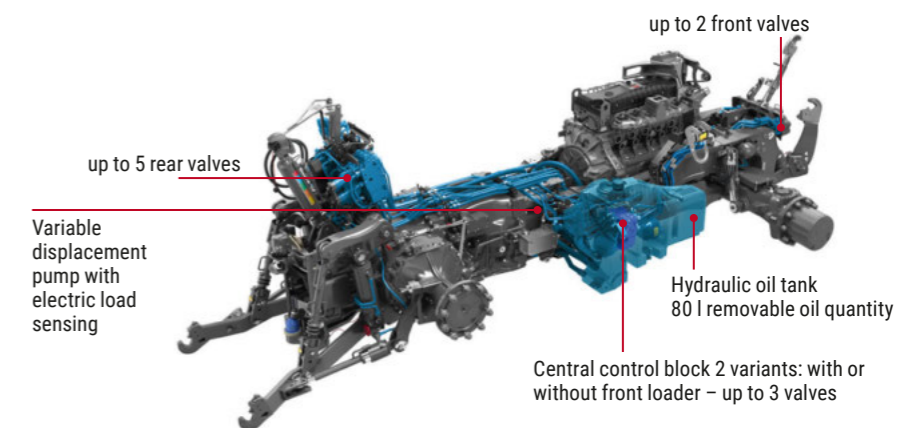



### 1. Rear power lift build

- EHR with comfort operation
- High lifting force: max. 11,050 daN
- Double-acting lifting cylinder
- Double-acting power lift/relief available with Profi and Profi+
- Draft measurement via force measuring pin
- Rear operation on left and right mudguards
- Active vibration damping for road travel with attachments (control via pressure sensors on the lift cylinders)

- Mechanical or hydraulic lower link side stabilisation, both variants with mechanical centre centring
- Load-compensated lowering for constant lowering speed
- Load-relief control regulation available
- Parking position for lower link
- Lifting aid available for hydraulic top link



- + Vibration damping
- + External operation on both sides
- + Double acting rear linkage
- + Simple operation and adjustment via power lift operating module and terminal

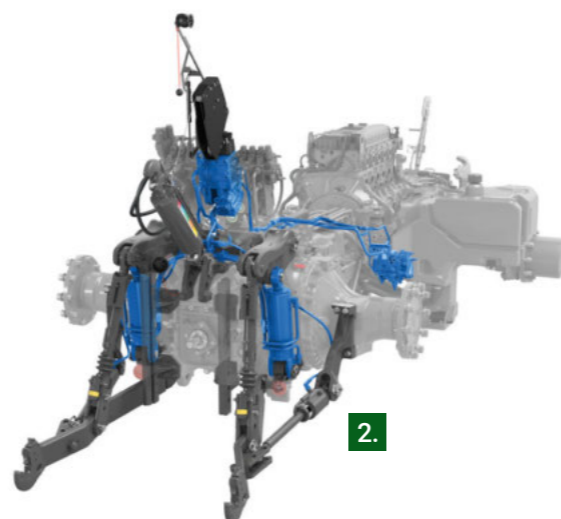

### 2. Relief control

- Ground-guided implements in three-point linkage, e.g. mulchers, are constantly guided at a constant working height even on uneven and soft ground
- Rear attachment actively follows the ground contour precisely with the infinitely adjustable contact pressure >> optimal working results
- Higher traction thanks to weight transfer from the implement to the tractor
- Elimination of active readjustment by the driver



- + Advantages with heavy ground-guided attachments in three-point and soft ground
- + Optimum working results
- + Relief for the implement and higher traction thanks to weight transfer
- + Relief for the driver because readjustment is no longer necessary



### 3. Aids for top links

#### 1. Lifting aid for hydraulic top link (optional)

- Only available in combination with hydraulic top link
- Gas pressure damper assists the driver via a cable pull mechanism when hitching and unhitching an implement
- Takes up part of the top link weight and enables a back-friendly change of the top link angle when attaching implements

#### 2. Relief when repositioning the top link on the tractor

##### Double function of the top link holder:

- Top link holder with integrated ball holds the top link in the parked position when no implement is mounted
- Gas struts on the top link holder takes the weight of the top link
- Weight relief for the driver if the top link position has to be changed and the top link is re-positioned in the hole pattern



- + Enormous relief and increased safety when hitching and unhitching the top link



**1. Front power lift – Choice of 3 variants**

- High max. lifting force: 5,300 daN; 32.6 kN continuous lifting force; max. unit weight: 3,750 kg
- Front power lift fully integrated into waisted half-frame to keep the unit short for the best manoeuvrability
- Folded lower links right up close to the vehicle
- Built-in side protection without protruding lines
- 3 front power lift variants depending on your needs
- Top links with solid brackets and easy handling
- Leakage oil reservoir for auxiliary control units integrated in lower link frame
- Easy attachment of implements with camera in the bonnet (optional)

**Variants:**

- Without front power lift
- Comfort ballast pick-up without front power lift
- Front power lift (single acting) Cat. 2 with position control
- Comfort front power lift (double acting) Cat. 2 with position control and relief control



**Benefits**

- + Integrated design, foldable/removable
- + High lifting capacity for a wide range of applications
- + No restrictions on the working hydraulics due to FKH (own hydraulic valve)
- + Vibration damping with nitrogen accumulator for implementation protection and driving comfort
- + Built-in cylinder protection with bellows
- + Simple operation and adjustment via power lift operating module and terminal
- + Relieving control for front mower use without additional relief springs or optimum steering ability with front packer use

**2. Comfort front power lift with position control and load relief control**

- Active, dynamic control of the bearing/relief pressure between 3 – 100 bar, on the terminal
- Load relief effect adjustable thanks to pressure relief valve
- Simple and convenient setting of the relief effect in the terminal
- Position sensor on front power lift for detecting unevenness
- From speeds from > 0.6 km/h
- No mower relief springs necessary



- + Enables work that is gentle on the equipment
- + Optimum ground hugging, thus protecting the sward when mowing and less forage contamination/higher forage quality
- + Ensuring directional stability by loading the front axle depending on the area of use

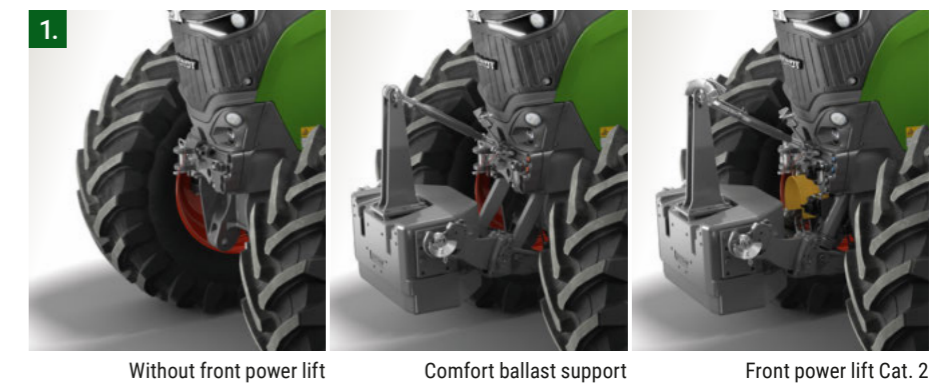
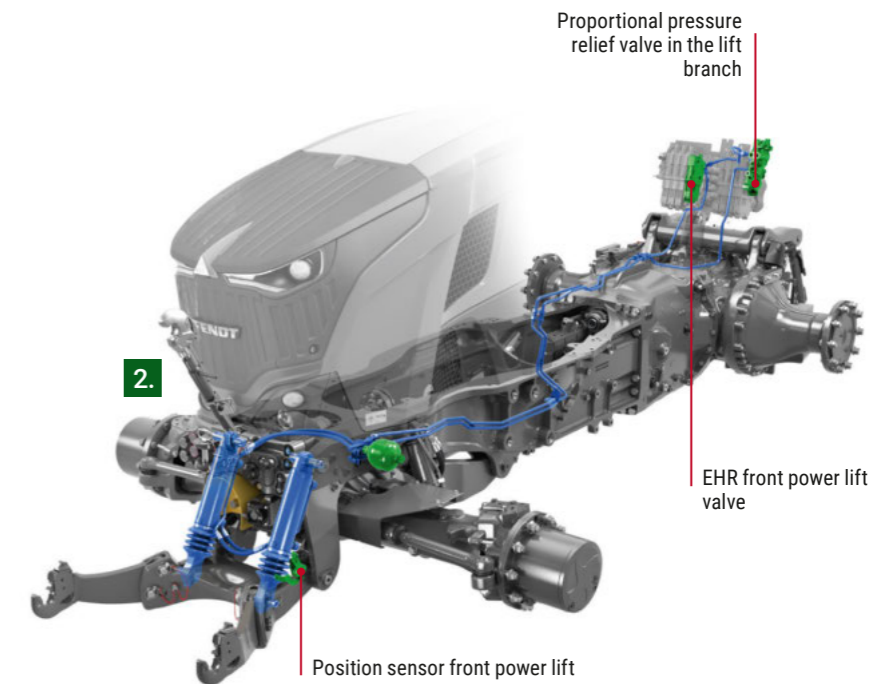





## Structure.

The Fendt 700 Vario Gen7 has been designed to cope with a wide range of applications. Superior manoeuvrability, a low power-to-weight ratio and many other aspects make it flexible like no other.



### 1. Unsurpassed manoeuvrability

- Vehicle optimised for the smallest possible turning radius:
  - Half frame with waist
  - Narrow compact fan allows for a slim bonnet
  - Increased steering angle without wind-up in the drive train
  - In the field, 10% smaller turning circle due to "pull-in-turn" effect
- Turning radius of only:
  - 10.0 m with 540/65 R30 tyres (for comparison: another 2.2 m better than a Fendt 724 Gen6 with a turning radius of 12.2 m with 540/65 R30 tyres)
  - 11.8 m with 600/70 R30 tyres
  - >> outstanding manoeuvrability in the 300 hp class
- Swivelling mudguards



- + Outstanding manoeuvrability for maximum flexibility without torsion in the drive train
- + With smart, independent 4WD, more manoeuvrable than conventional tractors without 4WD thanks to the pull-in turn effect
- + Predestined for front loader work

1.



### 2. High ground clearance

- With up to 57 cm (with 650/85 R38 tyres) extremely high ground clearance >> Plant protection and fertilisation also possible in late growth stages
- Swivelling mudguards at the front for better wheel turn-in

### Low power-to-weight ratio of only 30.5 kg/hp combined with maximum payload

- Fendt 728 Vario impresses with 9,200 kg (empty weight MCM\*) or 30.5 kg/hp thanks to intelligent, lightweight construction with flexible ballasting options >> more soil protection
- High payload of up to 5.8 t (726 – 728) – 6.2 t (720 – 724) with a permissible gross weight of 15 t (40/50 km/h version)
- Flexible ballasting via front and wheel weights
- Outstanding manoeuvrability: turn radius of 10.0 m

\* Most common model (MCM): full tanks, front power lift, rear power lift, rear mechanical top link, full valve equipment; Fendt 728 Vario Gen7: Front tyres - 600/70 R30, rear tyres - 710/70 R42

2.

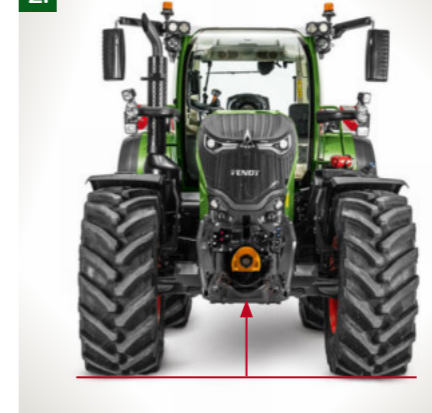

3.



### 3. Rear axle concept

- 60" variant for Row Crop markets\*
- Twin tyres up to 710/70 R42
- 3 rear axle variants:
  - Rear axle flange
  - Stub rear axle 2,500 mm
  - Stub rear axle 3,000 mm\*
- Radial rotary unions as well as lines and bores for tyre pressure control system for flange and stub axle
- Max. rear axle load:
  - 10.5 t for track widths outside of the 1,950 – 2,070 mm range
  - 11.5 t for track widths from 1,950 to 2,070 mm
- Large tyres with max. diameter of 2.05 m for more tractive force transmission
- Pneumatic brake actuation via 2 Tristop cylinders
- Steering brake as an option

\*country specific



- + Many tyre options for different uses
- + Tyre pressure control for single and twin tyres (Row Crop only)
- + Components for tyre pressure control fully integrated and protected



### 1. Front axle concept

- Level-controlled front axle suspension with 100 % lock and 120 mm suspension travel – lockable
- FSC (Fendt Stability Control) roll support
- High axle loads – Front axle load – 6,900 kg/incl Front loader at 9,980 up to 8 km/h
- 20% higher steering ability – Twin tyres
- Reaction steering with reset torque – stable straight-ahead driving

### Self-levelling, lockable front axle suspension

- Level-controlled, maintenance-free front axle suspension: 120 mm suspension travel increases area performance by up to 7 % thanks to permanent traction
- Best driving safety even on slopes or when working with a front loader, with the ever powerful Vario drive
- Consistently easy driving whatever the load, with self-levelling system and position sensor
- Lockable suspension: for precision loading work or with a front cultivator and even working depth

- No swinging up after raising/lowering
- Suspension system with longitudinal arm
- Front-axle swing is maintained even with suspension locked
- Full spring capacity available when stationary – Ballast attachment without front power lift
- Manual lowering/lifting for attachment/detachment of the implement via push-button (if no front power lift is installed)

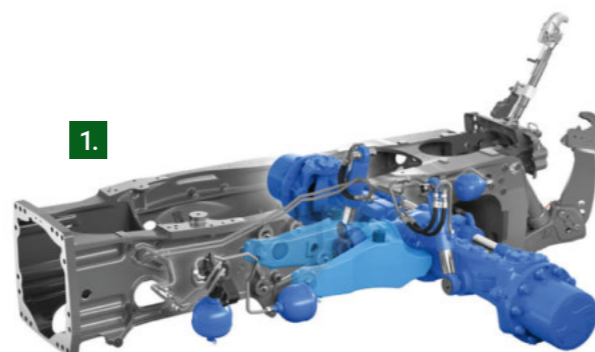

- + Higher area output
- + Optimum manoeuvrability
- + High permissible front axle load

### 2. Fendt Reaction steering and superimposed steering system

- Fendt Reaction steering system with built-in reset torque for safe straight-ahead driving and precise steering, turning and driving comfort like in a car
- FendtActive superimposed steering (in conjunction with Profi+ equipment)
- Application benefits: full steering angle with just one turn of the steering wheel at the headland or during front loader work
- Preselection in the terminal, activation on the multifunction armrest button
- Fendt Active uses the Fendt Guide steering valve
- Tractor drives with active superimposed steering max. 25 km/h
- Up to 8 km/h without restrictions, from 8 to 18 km/h, there's a linear reduction of the superimposed steering



- + Fast and comfortable turning at the headland by halving the steering wheel revolutions
- + Very good ground protection in conjunction with the driven front axle

### 3. Safety assistance systems - Fendt Stability Control (FSC)

- Speed-dependent, self-activating system for lateral stabilisation
- Integrated FSC stabilises the tractor by damping the lateral tilt
- FSC ensures maximum steering precision, driving stability and braking safety in all applications
- From 20 km/h, Fendt Stability Control (FSC) locks the balance between the right and left side of the front axle suspension, ensuring maximum steering precision, driving stability and braking safety in all applications



**Without VarioActive:**  
1x turn of the steering wheel = 26.6°

**With VarioActive:**  
1x turn of the steering wheel = 43.3°



**Without FSC**  
Tractor goes off line

**With FSC**  
Tractor stays on line



1.

### 1. Safety assistance system

- Safety feature that stabilises the combination with a pneumatically braked trailer in critical situations
- Continuous monitoring of the trailer's thrust on the tractor
- Brake pressure is automatically controlled in critical situations without the need to press the brake pedal:
- Is only activated when required (up to 25 km/h) and provides additional safety while protecting the field or grass sward at the same time
- Depending on speed and trailer load
- Assistant can be switched off by the driver if required
- No hill descent assistance system like the permanent brake on a lorry; does not replace a wear-free permanent brake

### Maximum soil protection and traction

- Diameter of up to 2.05 m at the rear with standard 650/85 R38 or optional 710/70 R42 tyres and 1.60 m at the front with standard 540/65 R34 or optional 600/70 R30 tyres
- New hybrid tyres available
- Permanent, tension-free 4WD: perfect symbiosis of max. tractive power, superior ground protection on any surface with superior manoeuvrability



- + Large selection of tyre options
- + Large tyres in conjunction with VarioGrip tyre pressure control system for up to 10% more traction/area performance and maximum ground protection
- + Independent permanent 4WD (VarioDrive)

### 2. VarioGrip for flange and stub axle

- VarioGrip available for flange and stub axle. Pressure adjustment can also be realised with twin tyres >> unique
- Complete integration with built in valve and air lines
- Complete solution with water-cooled high-performance compressor (dual compressor) with 630 cm<sup>3</sup> air flow rate
- Fendt's own development with radial rotary unions on front and rear axle
- Two-line technology with control and filling line
- Control line opens tyre valve; inflation line is used for inflation and deflation
- Two pressures for front and rear axle can be stored and recalled
- System air pressure is only present during air pressure control/ measurement
- Air pressure control also possible at full speed



- + Full integration into the vehicle concept with modified vehicle compressor and own valve technology
- + Up to 10 % more tractive power and reduction of fuel consumption by up to 8 % with 8 % more area output\*
- + No blanket air pressure, but individually adapted tyre pressure for use and ground conditions
- + Increased driving stability and safety during transport work
- + Reduction of rolling resistance to reduce fuelconsumption
- + Tyre protection for low operating costs
- + Maximum convenience through simple operation in the terminal
- + Significant reduction of surface pressure for soil conservation
- + Flexibility of use due to fast inflation and deflation times

\*South Westphalia University of Applied Sciences; Agricultural Economics Soest



2.



## Cab.

Your new favourite place. From a new premium driver's seat including massage function to a large cooler and hot box for your food. With the cab of the Fendt 700 Vario Gen7, you are ideally equipped for long working days.



1.

### 1. Features

- Spacious cab (2,520 l total room volume) with a continuous field of vision of 77°; ideal for front loader work
- VisioPlus cabin in 3 different variants
- Low noise level and excellent all-round visibility (6.1 m<sup>2</sup> glass surface)
- Wide and therefore comfortable entry
- FendtONE operating philosophy
- New premium driver's seat for maximum comfort
- Passenger seat with padding and backrest
- Numerous storage and stowage options

- Space for a large cooler and warmer for long working days
- Infotainment packages and sound system available
- Crossed work lights for glare-free lighting in the dark without shadows
- Pivoting steering column with digital dashboard
- Rear-view mirror with integrated wide-angle component as standard
  - optional: electrically adjustable and telescopic, heated rear-view mirrors
- Air conditioning or automatic air conditioning >> 30 % higher cooling under full load compared to the predecessor model

- Dashboard pivots with steering wheel
- Optional immobiliser with coded key
- Various suspension systems
- Front roller sun blind
- Additional side window wiper on right side
- Safety kit with first aid kit, safety vest and warning triangle

New in the Fendt 700 Vario Gen7



### 2. Choice of three cab variants:

1. VisioPlus panoramic cab: windscreen and right-hand side of cab cannot be opened; completely drawn through
2. Panoramic cab VisioPlus + door right: continuous windscreen, door left and right
3. Standard cab VisioPlus: right door and windscreen open (right side continuous without a B-column and contains the door)
  - Two handles for closing when the windscreen can be opened >> very stable, tight position of the windscreen when closed
  - Improved extra handle on the rear window (perfectly accessible however tall the driver)

Exemplary pictures of the Fendt 500 Vario

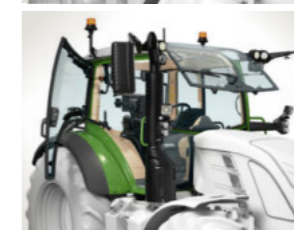
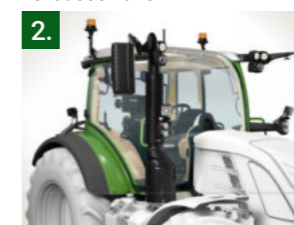

### Digital bonnet and rear camera

- High-resolution for the best image quality
- Good view of the front power lift or the implement in the rear
- Bonnet camera integrated in the Dieselross emblem
- Rear camera integrated in the cab roof next to the vehicle registration plate

### 3. Cab suspension – Choice between two variants:

1. Pneumatic (standard): two conical bearings at the front, two pneumatic spring elements at the rear
2. Pneumatic comfort (optional): 3-fold pneumatic (pneumatically suspended, central swing arm at the front and two pneumatic suspension elements at the rear)
  - Suspension is supported behind the rear axle, thus better spring deflection behaviour during braking and acceleration
  - Integrated level control
  - Integrated brake and pitch compensation thanks to higher front swing arm
  - Outstanding suspension comfort due to perfect interaction of cab, seat and front axle suspension as well as vibration damping at front and rear power lift

- + Maximum driving comfort for long working days, even under extreme conditions
- + Choice of different suspensions to suit every application
- + Sophisticated overall suspension concept



+ Wide choice of driver seats for best comfort

### 1. Comfort driver's seats

#### 6 different driver seats are available:

1. Comfort seat with air suspension: mechanical lumbar support, longitudinal horizontal suspension
2. Super comfort seat with air suspension: Seat heating, pneumatic lumbar support
3. Super comfort seat with high back, air suspension 3-point seat belt: incl. 3-point seat belt for optimum safety on the road (e.g. municipal) and high driving comfort
4. Super comfort seat EvolutionUp DualMotion/DL: seat climate control, seat heating, pneumatic lumbar support, lateral and longitudinal horizontal suspension, compressed air supply via vehicle compressor, dynamic damping, backrest extension (Dualmotion) can be moved to the left



5. Super comfort seat Titanium / DL: automatic weight adjustment, multi-stage seat climate control and heating, longitudinal adjustment, pneumatic lumbar support, side bolster adjustment, partial leather
6. Super comfort seat Titanium leather / DL electric: automatic weight adjustment, air-assisted height adjustment (stepless and automatic), multi-stage seat climate control and heating, automatic length adjustment, massage function, automatic backrest tilt adjustment, automatic side bolster adjustment, memory function, operation via terminal possible, genuine leather

### 2. Filter protection functions

- Exchangeable filter system from the factory according to EN15695: protection against dust, pesticides and their vapours
- Overpressure operation
- Cat. 4 Alternate filter system for plant protection application (optional)



### 3. Rear-view and comfort mirrors – three variants

Three different variants to choose from:

1. Rear-view mirror with wide angle mirror (mechanically adjustable)
  2. Comfort mirror rear and wide-angle mirrors electrically adjustable, heatable and clearance light\*
  3. Comfort mirror telescopic: rear-view and wide-angle mirrors electrically adjustable, heatable, and clearance light\* and mirror holder retractable and extendable
- As LIN mirror complete integration in vehicle electronics
  - Operation in the terminal
  - Function for simultaneous retraction of both mirrors
  - Marker lights in the mirror housing in conjunction with comfort mirrors (EU)
  - Best overview of dangerous zones when turning



\*NA version without marker light

### 4. Infotainment – Overview

Electronic platform for entertainment and communication includes four components:

1. Hands-free equipment
2. Highest quality radio reception worldwide
3. Connection of a wide range of external audio sources
4. Fully integrated operation via terminal or rotary knob on the armrest

#### Sound system in various expansion stages:

- Infotainment package: 4 premium speakers
- Infotainment package + 4.1 sound system (from Profi): 4 premium speakers plus subwoofer integrated in sound bar



- + Future-oriented infotainment system with many expansion options
- + Perfectly balanced sound in the cabin
- + Highest user comfort
- + Complete integration into the vehicle



**Equipment lines with different settings**  
 Two different settings can be selected for each equipment variant. All illustrations show standard equipment and optionally available front power lift.

- Equipment lines to choose from:**
- Power
  - Power+
  - Profi
  - Profi+

With "+" always guidance pre-fitting incl. guidance basic package included  
 Two different settings (Setting 1 and Setting 2) can be selected for each equipment line



- Power Setting 1**
- No cross-gate lever
  - One pair of finger tip spools (linear module) for operating the hydraulic valves



- Power Setting 2**
- Cross-gate lever
  - No finger tip spools (linear module) for operating the hydraulic valves



- Power+ Setting 1**
- Cross-gate lever
  - One pair of finger tip spools (linear module) for operating the hydraulic valves



- Power+ Setting 2**
- 3L-Joystick
  - One pair of finger tip spools (linear module) for operating the hydraulic valves



- Profi Setting 1 / Profi+ Setting 1**
- Cross-gate lever
  - Two pairs of finger tip spools (linear module) for operating the hydraulic valves



- Profi Setting 2 / Profi+ Setting 2**
- 3L-Joystick
  - Two pairs of finger tip spools (linear module) for operating the hydraulic valves







**1. Digital Dashboard**

- 10.1" large display (not touch capable)
- Fixed to the steering column, can be swivelled along with the steering column
- Different display modes:
  - Street and field mode
  - Day and night mode
- Display of messages (3 levels):
  - 1) Communication
  - 2) Warning message
  - 3) Alarm

- Choice between different views, e.g. hydraulic valves, key assignment, fuel consumption etc.

**2. 12" terminal on the armrest**

- Standard across all equipment variants
- Can be operated by touch and rotary-push dial
- Up to six freely configurable tiles per page
- Creation of user profiles to save page arrangements and settings for changing drivers
- Operable by touch and/or rotary-push dial
- Integrated day and night design

**3. 12" terminal in the roof**

- Additional 12" terminal in the roof for even more display space
- Functions correspond to the terminal on the armrest
- Can be half retracted into the roof lining: lower half is still visible even in retracted position



- + Basic functions are the same for all Fendt tractors >> Quick orientation for Fendt drivers
- + Possibility of individualisation thanks to freely assignable buttons
- + Less reaching around required thanks to central arrangement of the functions on the drive lever

**4. Multifunction joystick**

- Ergonomic shape and arrangement
- Fendt familiar operation of functions such as reversing, activation of cruise control and accelerating/decelerating is retained
- 4 additional keys with the possibility of function reassignment
- Rotary wheel on the driving lever for adjusting the cruise control speed while driving
- Important transmission functions such as cruise control preselection, TMS, speed memory, etc. located in the lower side area



**5. 3L-Joystick**

- Optional 3L-Joystick (with Power+ Setting 2, Profi Setting 2 and Profi+ Setting 2)
- Operation of the 3rd and 4th hydraulic control unit
- Fully ISOBUS-capable
- Up to 27 functions distributed over up to three operating levels (3L - 3 levels)
- Additional reverse key
- Functions can be reassigned via the IOM; colour feedback
- Entire 3L joystick can be locked for safety reasons



- + No need to reach around thanks to the reverse button
- + Freely customisable through function reassignment
- + Locking of the 3L joystick possible: prevention of unintentional operation

**Flexible key assignment via IOM (Individual Operation Manager)**

- The key assignment can be conveniently managed via the IOM
- Functions can be placed in the best possible operating location for the driver
- The functions can be placed at the respective operating location via drag & drop in the IOM menu
- Individual key assignment is stored in the respective user profile >> each driver can quickly call up their settings again
- 2 ways to get to the IOM in the terminal:
  - Quick-access button on the rotary-push dial
  - via the icon on the Launchpad



- + Flexible display of important data such as on-board computer, key assignment, etc.
- + Even when changing the standard view, the data relevant to the road traffic regulations continue to be displayed



- + 12" large display area
- + Intuitive operation (similar to smartphones and tablets)
- + Flat menu structure to easily find individual functions
- + Possibility of personalisation through freely configurable pages or tiles



## Smart Farming.

Today, a tractor is much more than just iron and steel. Intelligent technology solutions ensure that the fleet can be used with the greatest possible efficiency.



## Guidance system.

### Track guidance basic package

- Includes the tractor preparation for track guidance and the Fendt Guide application

### Option

- Choice of receivers (NovAtel or Trimble)
- Fendt Contour Assistant
- Fendt TI Headland (Fendt TI Auto + Fendt TI Turn Assistant)



- + Relief for the driver: Full concentration on the implement, easy control of the already worked area
- + Savings potential: Higher area output through full utilisation of the working width, at the same time minimisation of undesired overlaps and thus reduction of operating resource expenditure
- + Sustainable land management: minimising soil compaction by reducing the number of passes and optimising turning operations



NovAtel SMART7

1.



Trimble AG-482

### 1. Receiver selection with Fendt Guide

- 2 different GNSS receivers are possible:
  - NovAtel Receiver
  - Trimble receiver
- Each farm can individually select the receiver that best suits its requirements

### Fendt Contour Assistant

- The Fendt Contour Assistant supplements the known contour line types with the contour lines
  - Contour segments
  - Single contour
  - Individual wayline segments
- Available as a software option for the Power+ and Profi+ equipment variants



- + Choice between two powerful receivers
- + Variety of correction data signals of different accuracy levels
- + Upgrades and conversions possible at any time, even on older machines
- + Installation of the receiver under the roof hatch: Perfect protection against theft, weather and damage
- + In-fill mechanisms for signal failures (NovAtel RTK ASSIST & Trimble xFill (Premium))

### Fendt TI Headland

- Complete package for professional work on the headland
- Consists of the two functions
  - Fendt TI Auto
  - Fendt TI Turn Assistant
- Fendt TI Headland is available for all FendtONE machines from PL795 onwards

### 2. Fendt TI Headland – Fendt TI Turn Assistant

- Adds the automatic turning function to Fendt TI Auto
- Two different release modes:
  - Manual mode:
    - Manual initiation of the turning process
    - Field boundary not mandatory
  - Automatic mode:
    - Based on a given boundary line with headland settings, all turning operations are calculated
- The automatic mode contains four different turning types:
  - U-Turn
  - Part field mode
  - Y-Turn
  - K-Turn

2.

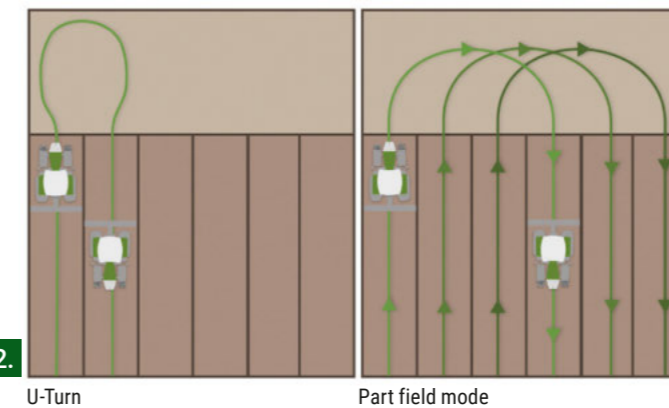

U-Turn

Part field mode

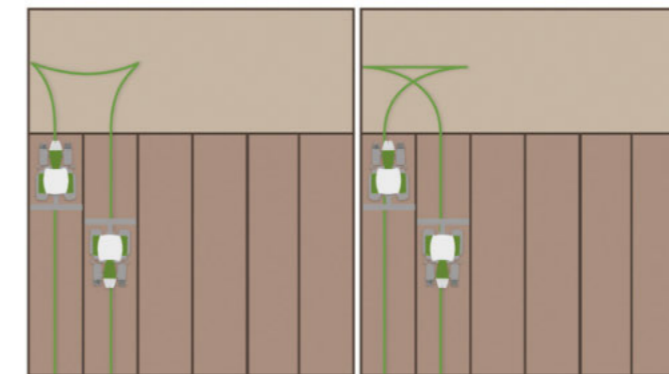

Y-Turn

K-Turn



- + Maximum driver relief
- + Maximum precision and efficiency
- + Savings in turning times and operating resources
- + Soil protection through optimal turning processes



## Agronomy.

### Agronomy basic package

- The Agronomy basic package includes the task-related documentation system Fendt TaskDoc and the associated offboard component
- It includes a three-year TaskDoc server licence, which is required for mobile data transfer between FendtONE offboard (or a farm management system) and the tractor

### Option

- agrirouter

### agrirouter

- Web-based data exchange platform that enables cross-manufacturer data transfer between machines and agricultural software
- Via an agrirouter account, for example, agronomy data can be sent

wirelessly from an FMIS to the Fendt terminal and vice versa

- Data transmission in standardised format
- Can be used in conjunction with FendtONE:
  - Through the agrirouter, other farm management systems can also be connected to FendtONE >> wireless data exchange between Fendt terminal and other FMIS\*

### Prerequisite

- Agronomy basic package



- + Overview of tasks and assignments
- + Simplified documentation of tasks and field work
- + Complete documentation of the field work
- + Also prepared for future documentation efforts



- + Barrier-free data transfer even with mixed machine parks\*
- + Transparency and data control: Determination of data transmission routes
- + Data security: no data storage

## Telemetry.

### Telemetry basic package

The Telemetry Basic Package contains all the components for the use of the Fendt Connect telemetry solution

- ACM box
- Licence to use Fendt Connect for five years
- Fendt Connect Web Application and App

The Fendt Smart Connect product can be ordered as an option.

### Fendt Connect

- Fendt Connect is the central telemetry solution for Fendt machines
- With Fendt Connect, machine data is recorded and evaluated so that farms and contractors can monitor, analyse and optimise the condition and use of their machines
- Thanks to mobile data transmission, current machine data can be called up from anywhere – via farm PC, tablet or smartphone



- + Increased efficiency through better logistics decisions
- + Input reduction: monitor consumption to improve performance
- + Maximise uptime through intelligent service appointment planning
- + Minimise downtime: Use of diagnostic support for decision making
- + Flexibility: Recall current machine data from anywhere

### Fendt Smart Connect

- Fendt Smart Connect can be booked as an option to the basic telemetry package
- Fendt Smart Connect allows machine parameters to be visualised on an iPad, e.g. engine speed, slip, fuel and AdBlue consumption, engine load, etc.
- In addition to mobile radio, the ACM Box is equipped with its own WLAN, which enables data transmission to the Fendt Smart Connect App
- With Fendt Smart Connect, the driver is provided with an additional display surface that can be individually adapted
- There is no permanent data storage



- + Free additional display space in the cabin
- + Intuitive operation through familiar hardware and operating logic
- + Full data control - no permanent data storage

\* if the respective agricultural technology or agricultural software manufacturer is a member of the agrirouter consortium, more information at [www.my-agrirouter.com](http://www.my-agrirouter.com)

# Machine control.



## Machine control unit basic package

- Prerequisite for further ISOBUS functions
- Simple and intuitive control of ISOBUS implements via standardised, cross-manufacturer interface Standard ISO 11783
- Tractor terminal and implement are connected by means of a socket at the rear

### Option

- Fendt Section Control (SC)
- Fendt Variable Rate Control (VRC)
- Fendt Implement Management (TIM & TIM-Steering)
- Front unit control



- + Increasing the efficiency of the team
- + Increasing the quality of work
- + Maximum range of functions for controlling ISOBUS devices
- + Simple operation of complex attachments
- + Basis for site-specific processing



- + Savings of up to 15 % on fertilisers, sprays, seeds, etc. by avoiding unwanted overlaps
- + Reduction of disease, pest and weed pressure by avoiding overly dense stands and missing areas
- + Relief for the driver, full concentration on monitoring the implement
- + Increasing the quality of work through clean connections at the headland

## Fendt Section Control

- Section Control is the automatic boom section control for ISOBUS implements
- This function is made possible by the Task Controller Section Control (TC-SC)
- The task controller documents where the area has already been processed and passes on the necessary switching commands to the machine's job computer, which switches the booms sections accordingly
- Headland mode: possibility to work the inside of the field first and then the headland
- Prerequisites: Fendt Guide, activation of TC-SC on tractor and implement

## Fendt Section Control with Multi Device Control ("Multi Boom") and 144 boom sections

- Function extension for Fendt Section Control
- Up to now, the automatic boom section control could only be used on one implement/one application unit ("boom") at a time
- With Multi Device Control, boom sections for up to five application units can be switched independently of each other (useful, for example, when sowing maize with a fertiliser tank)
- In addition, Section Control now supports up to 144 booms



- + Control of several units simultaneously

## Fendt Variable Rate Control (VRC)

- Variable Rate Control (VRC) is the site-specific control of the application rate of operating resources (seed, crop protection products or fertiliser)
- Basics: application map created in advance with the help of an FMIS
- Application map is transmitted to the machine as part of a task as an ISOXML file via mobile radio or USB (Shape format also compatible, transferable only via USB)
- The TC-GEO task controller automatically adjusts the specified target application rates depending on the position
- After completion of the task, send back an task report with the actually applied quantities to the FMIS
- Prerequisites: Fendt Guide, Agronomy basic package, Fendt Section Control and activation for the ISOBUS standard TC-GEO for tractor and implement



- + Increasing efficiency: maximising yield per unit area while saving on operating resources
- + Time saving: use of the task report as a basis for documentation
- + Flexibility: Support of ISOXML and Shape files

## New: Fendt Variable Rate Control (VRC) with Zone Control

- Function extension for Fendt Variable Rate Control
- Until now, the application rate could only be controlled over the entire working width
- With Zone Control, the application rate can now be regulated per boom section (zone) (provided the implement is equipped accordingly)
- Support for up to 144 zones



- + Even more demand-oriented application of operating resources
- + Especially useful for larger working widths

## Fendt Implement Management (TIM)

- With Tractor Implement Management (TIM), an implement can automatically control certain functions of the tractor, e.g. its forward speed or control valves
- This is possible as soon as both the tractor and the implement are equipped with the ISOBUS function TIM
- With the help of TIM, the implement optimises its own workload, the driver is relieved and the team works more productively
- TIM is available from PL795 for all FendtONE machines
- With Fendt Implement Management (TIM-Steering), the machine is able to receive steering commands from an attachment or an external steering system



- + Increasing the efficiency of the team
- + Maximum driver relief

## FendtONE offboard.

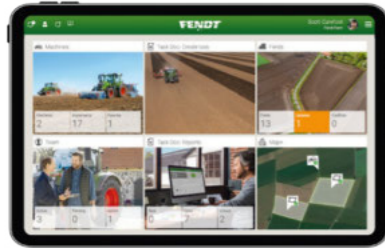

### 1. Comprehensive team management

- Overview of all employees and their roles in the operation (owner, driver, trainee, etc.)
- Varied authorization for different functions in FendtONE (read, write, no access)
- Establishing end dates for accounts

### 2. Efficient machine management

- Central overview of the machine fleet
- Telemetry information such as position, operating hours, error codes, AdBlue and diesel level
- Service information, warranty information, management of licenses

### 3. Precise field management

- Uniform field boundaries and waylines on all machines through rapid, seamless data exchange
- Optimization of AB lines in terms of number and length of waylines as well as the overlapped area

### 4. Simple task creation

- Create task with just a few clicks
- Wireless transfer to the machine
- Easy work coordination with employees: clear task assignment and reporting

### 5. Comprehensive task report

- Clear task report including relevant machine, field and agronomy data
- Time savings in documentation
- Task-related visualization of agronomy and machine data (forward speed, engine speed, application rate, deviation from target value, etc.) in Heat Maps

### 6. Intelligent location management

- Easily find locations that are relevant to operations (fields, field entrances, farmyards, stores) thanks to navigation based on Google Maps
- Simple location of machines
- View of the weather data to support action planning

### 1. More display surfaces

- Digital 10" dashboard: flexible display, important data such as on-board computer, button assignment, etc.
- 12" terminal on the armrest and cab roof: individual display of tractor operation, guidance, ISOBUS devices, infotainment, etc.

### 2. More operation options

- Multifunction joystick: more buttons can be freely assigned (also for ISOBUS function)
- 3L joystick: up to 27 functions across three operating levels (also for ISOBUS functions and operation of the front loader with a 3rd valve)
- Free assignment of buttons on the armrest
- No additional operating elements (terminals, joysticks) are necessary

### 3. Can be personalised

- Creation of user profiles to save settings for different drivers
- Assignment of admin rights
- Personalization of the display surfaces
- Free assignment of buttons and visual feedback to avoid operating errors

## FendtONE onboard.



### 4. Simple operation

- All of the operating elements in one central location
- Intuitive operation (similar to smartphones and tablets)
- Flat menu structure to easily find individual functions
- Colour-coded labelling of the various function groups
- Proportional operation of the linkage
- Proportional operation of the hydraulic valves on the multifunction joystick
- Display of messages in clear text

### 5. Future-proof

- Large memory capacity
- More interfaces
- High connectivity



The same user interface

Seamless integration of data

# FendtONE offboard.

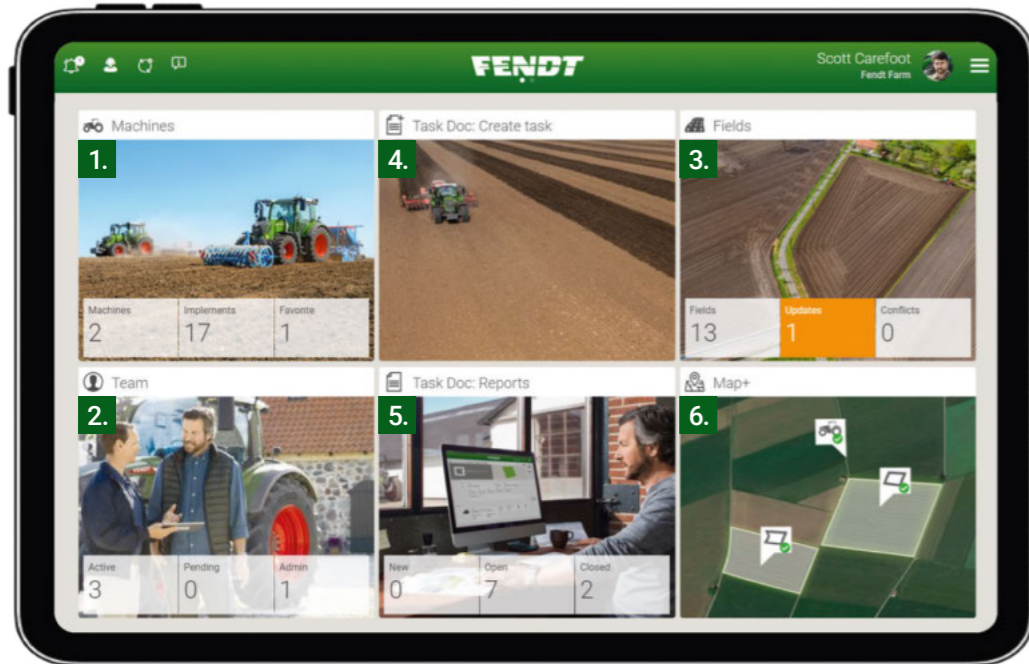

6 different main functions

## 1. Machines

Efficient machine management

- Overview of the machine fleet
- Machine information such as model, VIN number (serial number), year of manufacture
- Telemetry data such as position, operating hours, AdBlue and diesel fill level
- Task Doc Licence Management



- + Central location for all relevant machine data to avoid data loss
- + Time-saving overview and management of service planning and licences

## 2. Team

Transparent team management

- Overview of the team with contact details
- Setting user roles and permissions
- Time limitation of access for individual team members possible



- + Central place for all relevant data of the team members
- + High data security through definition of user roles (assistant, buyer, fleet manager, mechanic, driver, other) and authorisations (edit, read, no access)

## 3. Fields

Precise field management

- Overview of the fields
- Filter function according to crop type
- Field information such as field size, field boundary, track lines, obstacles, crop type
- Position and visualisation on Google Maps
- Navigation assistant based on Google Maps



- + Location, device and user-independent access to field data
- + Central and secure location for all field data to avoid data loss in case of machine sale or updates
- + Uniform field boundaries and track lines on all machines through conflict management
- + Easy import of fields, track lines and obstacles from the tractor terminal (ISOXML, KML) or as shp file
- + Time-saving navigation to fields

## 4. & 5. Task Doc: Create Task & Task Reports

Easy order creation & comprehensive task report

- Creation of tasks in FendtONE offboard by selecting a work type, tractor, implement, team member, crop type and operating materials
- Transfer of the job wirelessly or via USB stick to the machine
- Receiving task reports with all relevant machine, field and agronomy data
- Task report visualises the machine and agronomy data in overview maps
- Export of the task report as PDF



- + Simple and central creation, management and documentation of tasks
- + Structured planning of tasks and management of operating resources
- + Automatic recording of task data on the tractor during field work
- + Automatic and time-saving documentation including all relevant machine, field and agronomy data
- + Detailed insights into the performance parameters of the machine

## 6. Map+

Intelligent site management

- Overview of fields, machines and points of interest (POI)
- Live positions of machines
- Field specific weather forecast
- Navigation assistant based on Google Maps



- + Easy orientation through a central overview of all locations relevant to operations
- + Improved organisation of machine activities
- + Precise weather forecast for better planning
- + Time-saving navigation to fields, machines and POIs



## Front loader.

Flexible like no other. The new Fendt Cargo 6.100 front loader generation, developed especially for the Fendt 700 Vario Gen7, leaves nothing to be desired and comes up with sophisticated functions.





**Fendt Cargo 6.100 at a glance**

- New front loader generation with a continuous lifting force of 3,290 daN and a max. continuous lifting capacity of 4,070 daN, 4.85 m max. lifting height and a swing arm width of 1,140 mm for outstanding loading performance, combined with extreme manoeuvrability in the 300 hp class
- New multi-coupler:
  - 4-hose/6-hose cross-compatible with each other
  - Less pressure loss
  - Dirt cover

- Own valve block with up to 3 separate valves >> No corresponding lines
- New universal bucket with 2.55 m width and reinforced interface available

**CargoProfi features**

- Integrated weighing function in each position (individual and total weight)
- Limitation of the working range (lifting height and tipping angle)
- Memo function (storage of boom and tool position)
- Smart maintenance display of lubrication cycles via terminal – measures the actual front loader movements performed by the attachment and arm
- Shaking function (for shaking out sticky loads)
- End position damping (minimisation of trickle losses)

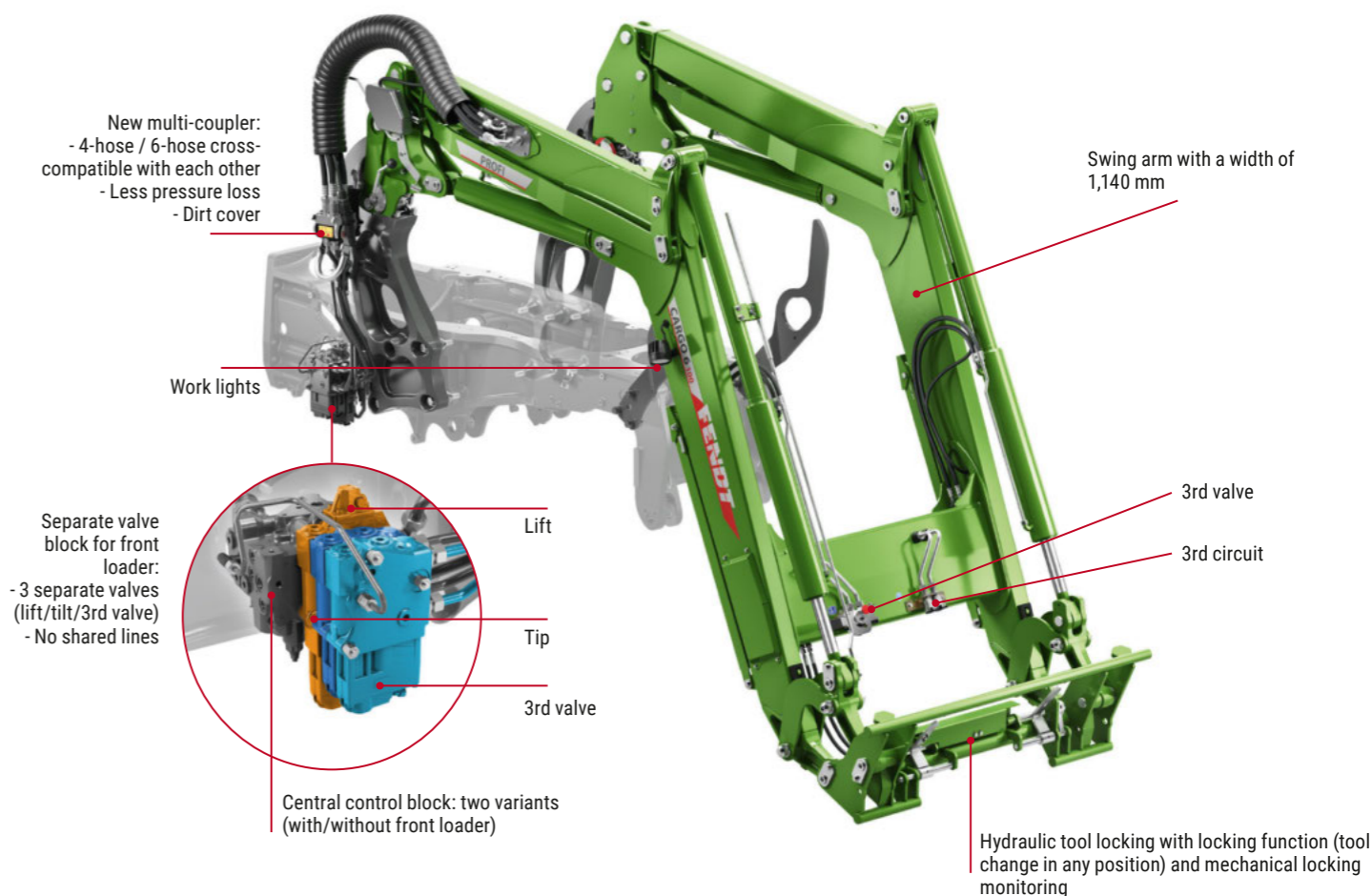



## Fendt Services.

A Fendt machine is a high-tech product for the highest of demands. Accordingly, the certified Fendt sales partners offer first-class service.



+44 330 123 9909

You can contact the certified service partners around the clock via the Fendt Customer Hotline



**The best product under the best protective shield**

- Extraordinary service partners and service:
- A short distance between our trained service employees and you
  - 24/7 Replacement parts availability during the season
  - 12 month guarantee on Fendt original parts and installation

**100 % quality. 100 % Service: Fendt Services**

- Fendt Demonstration Service
- Fendt Expert Driver Training
- AGCO Finance – Financing and Leasing Offers
- Fendt Care – Service contracts and warranty extension
- Fendt Certified – Used machine programme

**Ensure the operation of tomorrow today.**

- Fendt Demonstration Service**
- Get on and try it out, instead of just talking about it
  - Basis for an optimal decision-making process

- Fendt Expert Driver Training**
- Exclusive practical training with professional trainers
  - Optimization of efficiency by learning all of the functions and exploiting the entire performance potential of the Fendt machine

- Individual financing and leasing models**
- Credit financing by AGCO Finance with attractive conditions, flexible terms and projectable costs
  - Tailored leasing offers via the Fendt sales partner



- Fendt Care – Service contracts and warranty extension**
- Tailored maintenance and repair service that goes beyond the warranty
  - Maximum safety of use
  - Flexible terms and rates with and without deductible
  - Full cost control and planning security
  - Only original parts used with guaranteed production quality and tested for reliability for maximum value retention of the Fendt machine

- Fendt Certified – Used machine programme**
- Used agricultural machines with proven high-quality and certified Fendt quality
- Advantages:**
- Certification according to demanding quality standards
  - Extensive initial check (technology, wear, appearance)
  - Meticulous maintenance of wearing parts
  - replacement, cleaning and painting of components as needed
  - Includes warranty

\* Fendt Certified only available in GB/FR



## Fendt Care.

### Cost control and planning security with the Fendt Care rates

- Comprehensive range of services to ensure operational safety and repairs on new machines
- Full cost control with the best service
- Tailored solution for the fleet from maintenance contract to complete worry-free package including replacement machine

### Smartphone-App "AGCO Parts Books to go"

- Find replacement parts quickly and order directly
- Download via the App Store or the Google Play Store
- Access data via the Fendt sales partner

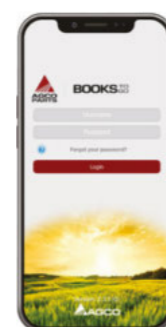







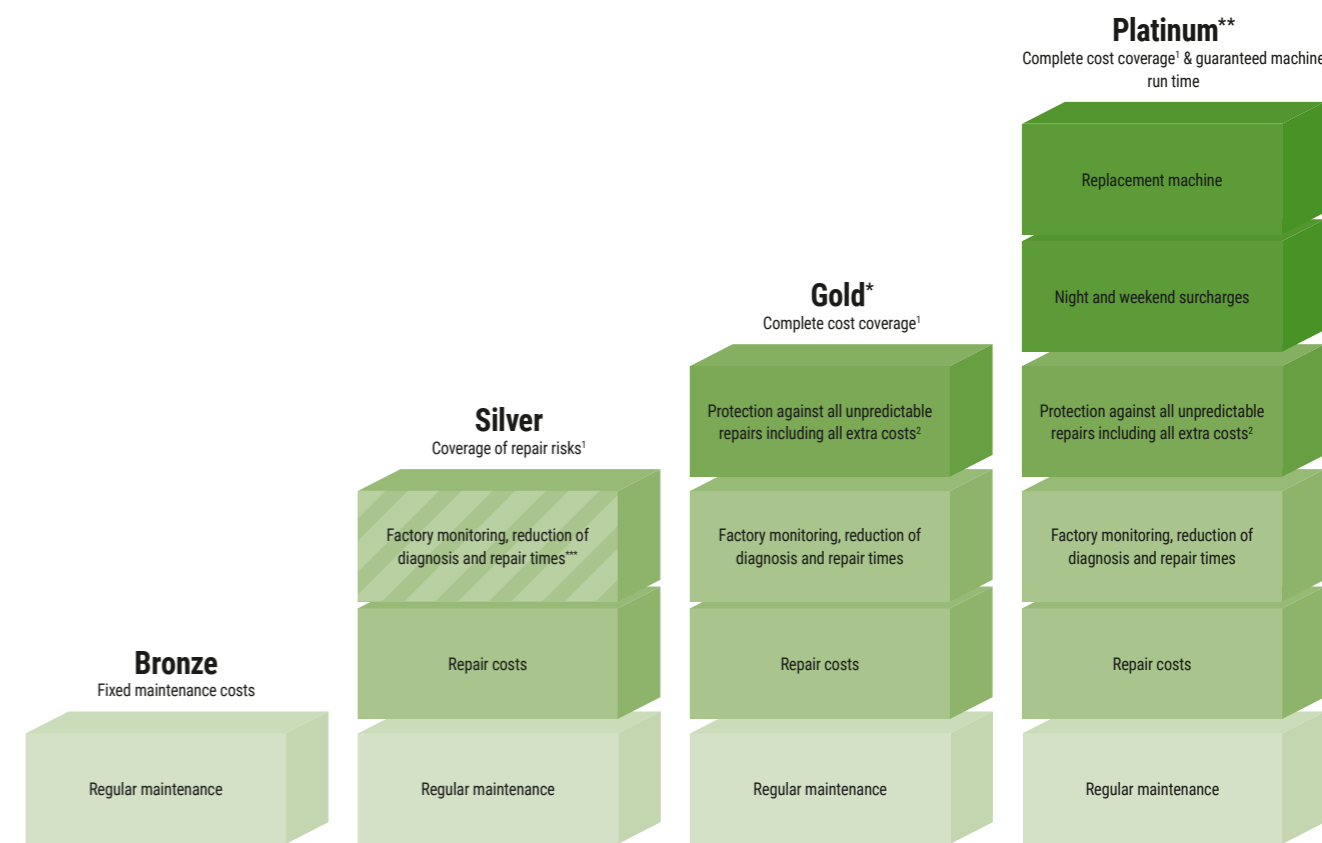





App Store



Google Play Store



		 Cost advantages with Fendt Connect (optional)	 Only for tractors with Fendt Connect
<b>Available for</b>	Complete Fendt Portfolio	Complete Fendt Portfolio	Wheeled tractor with Fendt Connect & telescopic loader <sup>8</sup>   Wheeled tractor with Fendt Connect
<b>Customer benefit (deductible)</b>	Operation safety of the machine	Coverage of large-scale damage <sup>3</sup> (490 €)  Comprehensive coverage at attractive rates (190 €)  Complete coverage with full cost control (0 €)	Complete coverage with full cost control including all extra costs (0 €)  Complete coverage with full cost control including all extra costs & guaranteed machine run time (0 €)
<b>Maximum coverage Warranty extension</b>	 8 Years / 8,000 OH	 5 Years / 3,000 OH    5 Years / 5,000 OH	 3 years / 2,000 OH <sup>4</sup>    3 years / 4,000 OH <sup>5</sup>    3 years / 25,000 bales <sup>6</sup>    5 Years / 50,000 Bales    8 Years / 4,000 pump-H    5 Years / 8,000 OH    5 years / 750 OH <sup>7</sup>

OH = operating hours; H = hours; <sup>1</sup> excluding wear and tear; <sup>2</sup> travel costs, recovery / towing, troubleshooting with additional diagnostic tools, use of dynamometer, oils and filters if engine / transmission is repaired; <sup>3</sup> only available for machines with self-propelled & RG300 & Momentum; <sup>4</sup> ISOBUS-enabled machines only; <sup>5</sup> PR, VR & XR only; <sup>6</sup> incl. Rollercor; <sup>7</sup> Momentum 16 & 24 only; <sup>8</sup> Gold rate for telehandler also available without Connect; <sup>\*</sup> Gold rate only available in DE, FR, GB, IT, BG, CZ, EE, HR, HU, LT, FI, LV, MD, RO, RS, SE, SI, SK, UA, AT, LU, NL, CH, BE, BY, NO, PL, DK; <sup>\*\*</sup> Platinum only available in DE, EN, FR; <sup>\*\*\*</sup> optional with Fendt Connect



## Equipment variants and technical details.

Dear customer,

Our motivation at Fendt is to provide you with the most innovative machines and solutions so that you can do your work even more efficiently and comfortably. We are constantly advancing our products and their equipment details. Therefore, you will find all technical data and equipment variants updated daily on our website.



Simply scan the QR code or follow the link below:  
[fendt.com/700-vario-gen7-data](https://fendt.com/700-vario-gen7-data)



**Lighting.**

- Working lights can be selected as required
- Daytime running lights and work lights in bonnet (optional)
- In conjunction with the bonnet lighting front camera in the Diesellox emblem
- Lighting optionally in LED version:
  - LED work lights at 4,000 lumens
  - LED recessed spotlight at 3,400 lumens
  - High-performance reflectors for uniform illumination without glare
  - Thermal management for long service life, low power consumption
  - Vibration-resistant and resistant to high-pressure cleaners
  - EMC-tested (track guidance, radio)
  - Salt test inspected
- LED work lights
- See me Home Light
- Illuminated steps
- Two light settings can be saved and conveniently recalled via a switch on the steering column or via the terminal



Technical Details.



Rear axle flange



Stub rear axle 3,000 mm twin tyres with dual wheel hub



Rear power lift with quick arresters and side support (EU)



Rear power lift with quick arresters and rub blocks (AU, South Africa, Eastern Europe)



Rear power lift with ball ends and rub blocks



Quick-hitch frame with hydraulic opening of the tail arrester as standard



**Front ballasting:**

- 870 kg
- 1,250 kg
- 1,800 kg

**Rear axle ballasting:**

- 2 x 300 kg
- 2 x 600 kg
- 2 x 1,000 kg

# FENDT

## Leaders drive Fendt.



[www.fendt.com](http://www.fendt.com)

AGCO GmbH – Fendt Marketing  
87616 Marktoberdorf, Germany

EN/2401



Fendt is a worldwide brand of AGCO.  
All details regarding scope of delivery, appearance, performance, dimensions and weights, fuel consumption and running costs of vehicles reflect the latest information available at the time of print. These may change by the time of purchase. Your Fendt dealer will be happy to inform you about any changes. The vehicles shown do not feature country-specific equipment.